

- Capacidad plegador: Diámetro 1.000 mm.  
Anchos desde 2.000 mm. hasta 3.000 mm.
- Velocidad máxima de trabajo: 300 metros/minuto.
- Factor de paro: metros y vueltas.
- Motores: Desde 11 KW hasta 15 KW.
- Equipo opcional:
  - Eliminator electricidad estática.
  - Camscan.
  - Modem comunicación.
  - Pulsador pedal doble.
  - Peine de cruces

- Beam capacity: diameter 1.000 mm.  
Width: from 1.000 mm up to 3.000 mm.
- Maximum working speed: 300 meters /minute.
- Stop parameters: meters and turns.
- Motors: From 11 KW up to 15 KW.
- Optional equipment:
  - Static electricity eliminator.
  - Camscan.
  - Communication modem.
  - Double button pedal.
  - Leasing device.

## EQUIPAMIENTO INSTALADO INSTALLED EQUIPMENT

	FIJACIÓN FLEGADOR   BEAM FIXATION		
	MANUAL MANUAL	NEUMÁTICO PNEUMATIC	HIDRÁULICO HYDRAULIC
	SUBIDA/BAJADA PLEGADOR   UP/DOWN OF THE BEAM		
	SÍ YES	NO NO	
	TAMBOR DE PRESIÓN   PRESSURE DRUM		
	OPCIONAL OPTIONAL	SÍ YES	NO NO
	RODILLOS DE PRESIÓN   PRESSURE ROLLERS		
	OPCIONAL OPTIONAL	SÍ YES	NO NO
	FRENO PLEGADOR   BEAM BRAKE		
	ELÉCTRICO ELECTRONIC	HIDRÁULICO HYDRAULIC	
	ANCHO PANTALLA TRABAJO   WIDTH OF WORKING SCREEN		
	PULGADAS INCHES	5"	7"

	VAIVÉN VERTICAL   VERTICAL "TO & FROM"	
	ESTÁNDAR STANDARD	OPCIONAL OPTIONAL
	VAIVÉN HORIZ. ELECTRÓNICO   ELECTRONICAL HRZ "TO & FROM"	
	ESTÁNDAR STANDARD	OPCIONAL OPTIONAL
	VAIVÉN HORIZ. MECÁNICO   MECHANICAL HRZ "TO & FROM"	
	ESTÁNDAR STANDARD	OPCIONAL OPTIONAL
	PEINE ZIG ZAG   ZIG ZAG COMB	
	ESTÁNDAR STANDARD	OPCIONAL OPTIONAL
	PEINE W   W COMB	
	ESTÁNDAR STANDARD	OPCIONAL OPTIONAL
	ARRASTRE PLEGADOR   BEAM PUSHING	
	PULGADAS   INCHES	
	4"	6"

## URDIDOR TRASCANADOR MODELO OR-T 40/42 CP (HILO RIGIDO) REWINDER WARPING MODEL OR-T 40/42 (RIGID YARN)

---

Máquina especialmente diseñada para trascarar (pasar de un plegador a otro), plegadores dañados, igualar perímetros, añadir o suprimir algunos hilos.

Totalmente automatizada, dispone de un cabezal de recogida y otro de entrega. Entre los dos encontramos un compensador basculante para corregir las pequeñas oscilaciones entre los cabezales.

Machine destined to rewind (to pass the threads from one beam to another one), damaged beams, to match beam perimeters, add or remove threads from the beam. Fully automatized, it is composed of two warping heads; one is acting as a collecting device and the other one as a delivering. There is a swiveling compensator between both warping heads which is correcting the small oscillations among them.

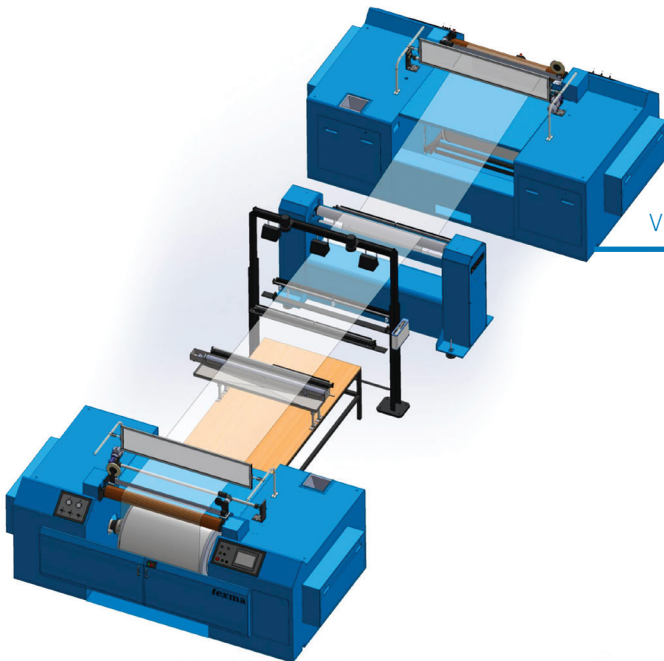

Vista de un equipo completo urdidor trascarador OR-T 40/42 CP

Frontal view of a rewinder warping machine OR-T 40/42 CP











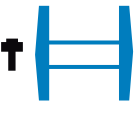

Compensador oscilante.  
Swiveling compensator.

- Capacidad plegador: Diámetro 40” (1.016 mm). Ancho máximo 42”.
- Velocidad máxima de trabajo: 600 metros/minuto.
- Factor de paro: metros y vueltas.
- Motores: 15 KW.
- Equipo opcional:
  - Eliminator electricidad estática.
  - Camscan.
  - Warpstop.
  - Parafinador.
  - Modem comunicación.
  - Pulsador pedal doble.

- Beam capacity: Diameter 40” (1.016 mm.). Maximum width 42”.
- Maximum working speed: 600 meters /minute.
- Stop parameters: meters and turns.
- Motors: 15 KW.
- Optional equipment:
  - Static electricity eliminator.
  - Camscan.
  - Warpstop.
  - Paraffin device.
  - Communication modem.
  - Double button pedal.

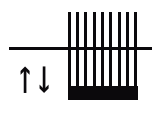
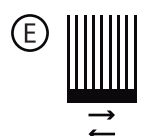
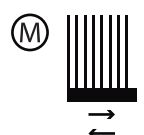
## EQUIPAMIENTO INSTALADO INSTALLED EQUIPMENT

	FIJACIÓN FLEGADOR   BEAM FIXATION			
	MANUAL MANUAL	NEUMÁTICO PNEUMATIC	HIDRÁULICO HYDRAULIC	
	SUBIDA/BAJADA PLEGADOR   UP/DOWN OF THE BEAM			
	SÍ YES	NO NO		
	TAMBOR DE PRESIÓN   PRESSURE DRUM			
	OPCIONAL OPTIONAL	SÍ YES	NO NO	
	RODILLOS DE PRESIÓN   PRESSURE ROLLERS			
	OPCIONAL OPTIONAL	SÍ YES	NO NO	
	FRENO PLEGADOR   BEAM BRAKE			
	ELÉCTRICO ELECTRONIC	HIDRÁULICO HYDRAULIC		
	ANCHO PANTALLA TRABAJO   WIDTH OF WORKING SCREEN			
	PULGADAS INCHES	5"	7"	10"

	VAIVÉN VERTICAL   VERTICAL "TO & FROM"		
	ESTÁNDAR STANDARD	OPCIONAL OPTIONAL	
	VAIVÉN HORIZ. ELECTRÓNICO   ELECTRONICAL HRZ "TO & FROM"		
	ESTÁNDAR STANDARD	OPCIONAL OPTIONAL	
	VAIVÉN HORIZ. MECÁNICO   MECHANICAL HRZ "TO & FROM"		
	ESTÁNDAR STANDARD	OPCIONAL OPTIONAL	
	PEINE ZIG ZAG   ZIG ZAG COMB		
	ESTÁNDAR STANDARD	OPCIONAL OPTIONAL	
	PEINE W   W COMB		
	ESTÁNDAR STANDARD	OPCIONAL OPTIONAL	
	ARRASTRE PLEGADOR   BEAM PUSHING		
	PULGADAS   INCHES	A DEFINIR   TO BE DEF.	
	4"	6"	

## URDIDOR SECCIONAL MODELO OR-25 CP SECTIONAL WARPING MACHINE MODEL OR-25 CP

Urdidor totalmente automatizado con control de perímetro, preparado para trabajar con todo tipo de hilos, naturales o sintéticos.

Fully automatized sectional warping machine, prepared to work with all types of yarn, both natural and synthetic.

### Modelos | Models

OR-25 CP 2000    OR-25 CP 3000  
OR-25 CP 2600    OR-25 CP 3600



Visita cabezal de enrollado y parafinador en urdidores OR-25 CP  
View of the warping head winder and paraffin device OR-25 CP

Vista urdidor seccional modelo OR-25 CP, 3.600 milímetros

View of sectional warping machine model OR-25 CP,  
3.600 millimeters



- **Velocidad máxima de trabajo: 1.000 metros / minuto (urdido), 150 metros/ minuto (enrollado).**
- **Factor de paro: metros y vueltas.**
- **Motores: Desde 15 KW a 20 KW.**
- **Gama de avances: desde 0.5 mm hasta 6.25 mm.**
- **Equipo opcional:**
  - **Eliminador electricidad estática.**
  - **Parafinador.**

- **Maximum working speed: 1.000 meters /minute (warping), 150 meters / minute (winding).**
- **Stop parameters: meters and turns.**
- **Motors: From 15 KW to 20 KW.**
- **Forward movement set: from 0,5 mm. to 6,25 mm.**
- **Optional equipment:**
  - **Static electricity eliminator.**
  - **Paraffin device.**



## ESTIRO URDIDOS DRAW WARPING MACHINE

Máquina totalmente automatizada con control de perímetro para producir plegadores en estiro urdido, tanto en proceso caliente como en frío, para hilos PA o PES.

Fully automatized machine, equipped with perimeter control system to produce beams by draw-warping cold or hot system, for PA or PES yarn.

### Modelos | Models

EUC 40/42 CP

EU4 40/42 CP

EUC 40/100 CP TANDEM

EU4 40/100 CP TANDEM

Cabezal complete EUC 40/42 CP

Complete warping head EUC 40/42 TANDEM



Mesa de termofijar

Sealing table

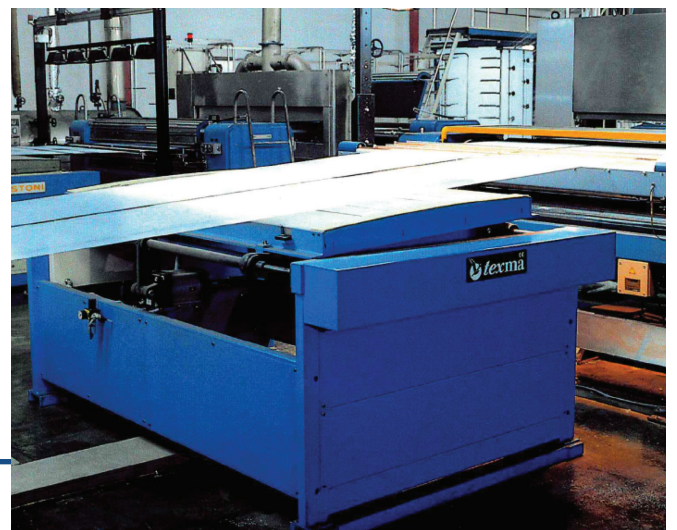

Compensador basculante

Swiveling compensator

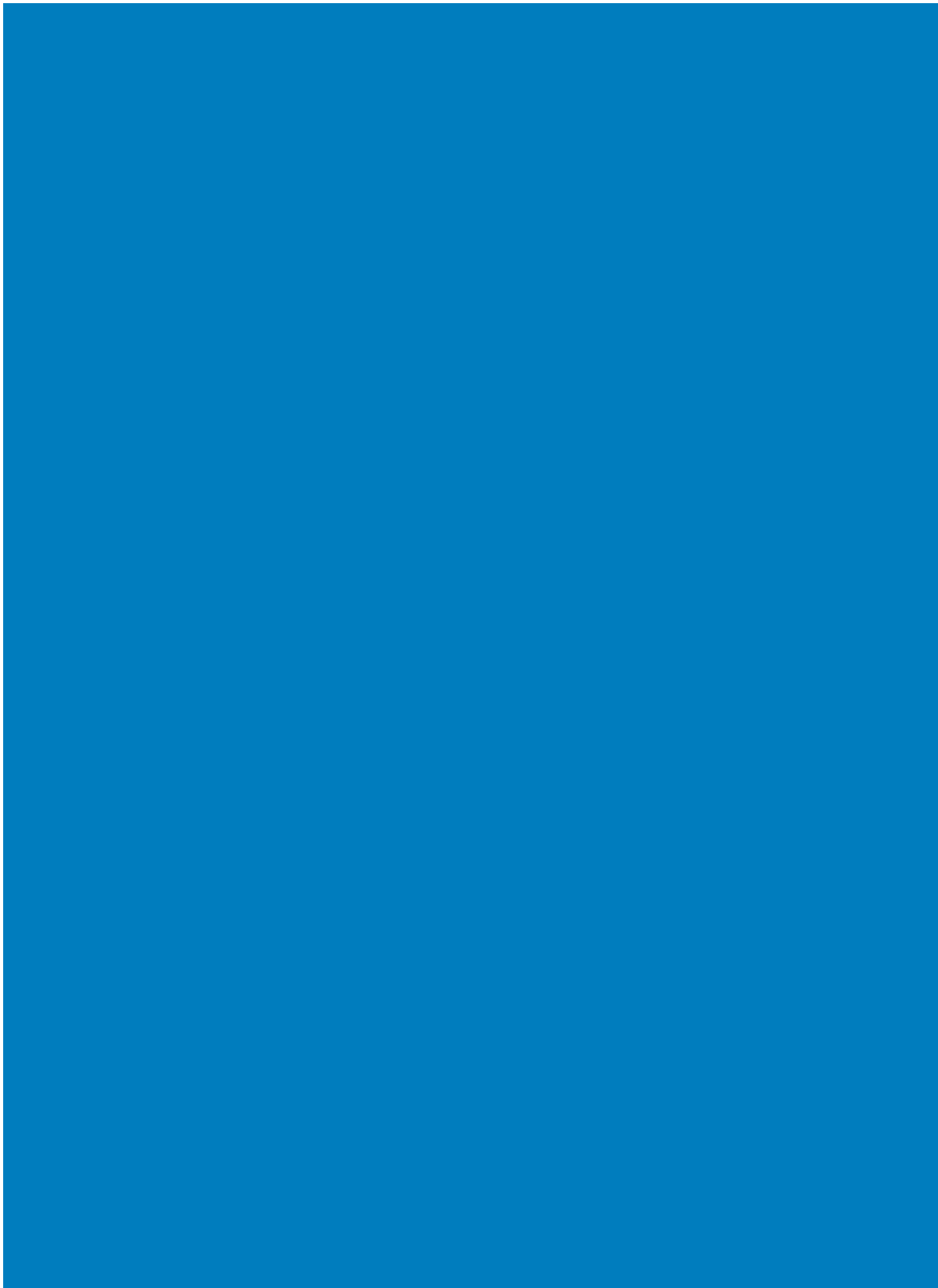

**FILETAS CREELS**

## FILETA MODELO FS (HILO RIGIDO) CREEL MODEL FS (RIGID YARN)

Fileta para alimentación de hilos en urdidores o máquinas de tejer, manteniendo fija la distancia entre el tensor y la bobina. Estas se cargan desde el exterior de la fileta, pasándolas entre las rejillas de tensores.

It is a creel to feed warping machines and looms. The distance between the tensioner and the bobbin is fixed. The bobbins are loaded from the outside of the creel being passed through the tensioner's panel.



### DATOS TÉCNICOS A DEFINIR | TECHNICAL SPECIFICATIONS TO BE DEFINED

SALIDA HILO INTERIOR / EXTERIOR	TO INSIDE   TO OUTSIDE THREAD EXIT	
HILOS TOTALES	TOTAL THREADS	
PISOS ALTURA	FLOORS HIGH	
HILERA DE FONDO	ROWS DEEP	
ACARTAMIENTO VERTICAL	VERTICAL DISTANCE BET. BOBBINS	
ACARTAMIENTO HORIZONTAL	HORITZONTAL DISTANCE BET. BOBBINS	
TIPO DE TENSOR	THREAD GUIDE TYPE	
TIPO DE PORTACONOS	TENSIONER TYPE	
TIPO GUÍA-HILOS	BOBBIN-HOLDER TYPE	
TIPO DE DISPARO	STOP-MOTION TYPE	



## FILETA MODELO FA (HILO RIGIDO) CREEL MODEL FA (RIGID YARN)

Fileta para alimentación de hilos en urdidores, con rejas porta tensores móviles lateralmente para facilitar el cambio de bobinas, pudiendo entrar en el interior de ella. En la reja de tensores se puede regular la distancia desde la bobina al tensor en función del hilo que trabaje.

It is a creel to feed yarn to warping machines, with cone holder panels, which can be laterally moved to facilitate the replacing of the bobbins. It is possible to go inside. The tensioner panel can adjust the distance of the tensioner to the bobbin, depending on the type of yarn.

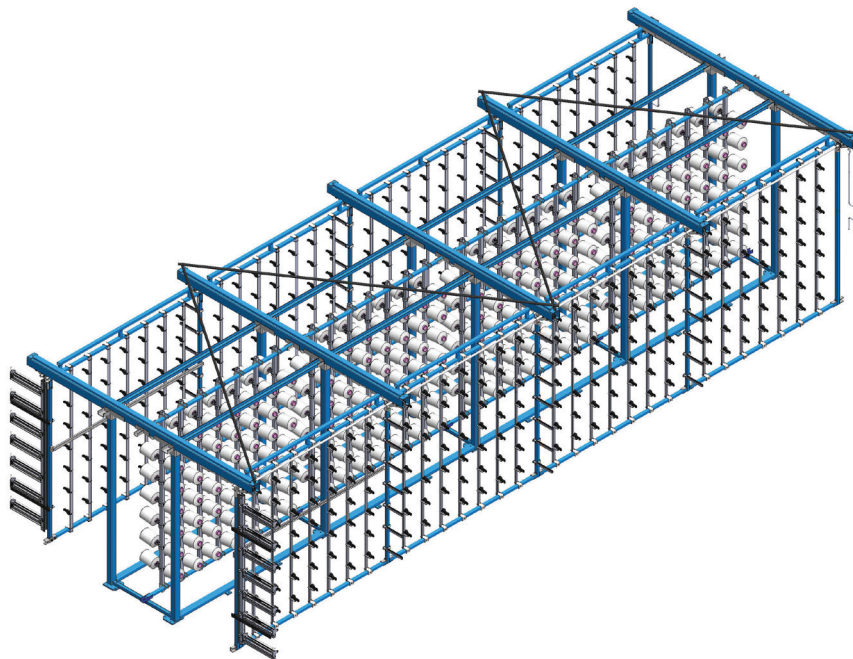

### DATOS TÉCNICOS A DEFINIR | TECHNICAL SPECIFICATIONS TO BE DEFINED

SALIDA HILO INTERIOR / EXTERIOR	TO INSIDE   TO OUTSIDE THREAD EXIT	
HILOS TOTALES	TOTAL THREADS	
PISOS ALTURA	FLOORS HIGH	
HILERA DE FONDO	ROWS DEEP	
ACARTAMIENTO VERTICAL	VERTICAL DISTANCE BET. BOBBINS	
ACARTAMIENTO HORIZONTAL	HORITZONTAL DISTANCE BET. BOBBINS	
TIPO DE TENSOR	THREAD GUIDE TYPE	
TIPO DE PORTACONOS	TENSIONER TYPE	
TIPO GUÍA-HILOS	BOBBIN-HOLDER TYPE	
TIPO DE DISPARO	STOP-MOTION TYPE	

## FILETA MODELO FPR (HILO RIGIDO) CREEL MODEL FPR (RIGID YARN)

Fileta para alimentación de hilos en urdidores u otras máquinas con sistema de reserva el cual facilita la carga de bobinas durante el proceso. Al cargar las bobinas desde el exterior, permite no tener que parar la máquina para realizar este proceso. La salida del hilo puede ser desde el interior o exterior.

It is a creel to feed warpers and other machines with reserve system to facilitate the loading process. This is done by the outside, and it allows doing it while the machine is running. The thread draw-off can be from inside or outside.



### DATOS TÉCNICOS A DEFINIR | TECHNICAL SPECIFICATIONS TO BE DEFINED

SALIDA HILO INTERIOR / EXTERIOR	TO INSIDE   TO OUTSIDE THREAD EXIT	
HILOS TOTALES	TOTAL THREADS	
PISOS ALTURA	FLOORS HIGH	
HILERA DE FONDO	ROWS DEEP	
ACARTAMIENTO VERTICAL	VERTICAL DISTANCE BET. BOBBINS	
ACARTAMIENTO HORIZONTAL	HORITZONTAL DISTANCE BET. BOBBINS	
TIPO DE TENSOR	THREAD GUIDE TYPE	
TIPO DE PORTACONOS	TENSIONER TYPE	
TIPO GUÍA-HILOS	BOBBIN-HOLDER TYPE	
TIPO DE DISPARO	STOP-MOTION TYPE	



## FILETA MODELO FPR 2 PLANTAS (HILO RIGIDO) CREEL MODEL FPR 2 FLOORS (RIGID YARN)

Fileta para alimentación de hilos en urdidores u otras máquinas con sistema de reserva el cual facilita la carga de bobinas durante el proceso. Al cargar las bobinas desde el exterior, permite no tener que parar la máquina para realizar este proceso. La salida del hilo puede ser desde el interior o exterior. Este modelo está construido en 2 plantas para optimizar el espacio.

It is a creel to feed warpers and other machines with reserve system to facilitate the loading process. This is done by the outside, allowing to do it while the machine is running. The thread draw-off can be done from inside or outside. This creel is built in 2 floors to optimize the space available.



### DATOS TÉCNICOS A DEFINIR | TECHNICAL SPECIFICATIONS TO BE DEFINED

SALIDA HILO INTERIOR / EXTERIOR	TO INSIDE   TO OUTSIDE THREAD EXIT	
HILOS TOTALES	TOTAL THREADS	
PISOS ALTURA	FLOORS HIGH	
HILERA DE FONDO	ROWS DEEP	
ACARTAMIENTO VERTICAL	VERTICAL DISTANCE BET. BOBBINS	
ACARTAMIENTO HORIZONTAL	HORITZONTAL DISTANCE BET. BOBBINS	
TIPO DE TENSOR	THREAD GUIDE TYPE	
TIPO DE PORTACONOS	TENSIONER TYPE	
TIPO GUÍA-HILOS	BOBBIN-HOLDER TYPE	
TIPO DE DISPARO	STOP-MOTION TYPE	

## FILETA MODELO FG (HILO RIGIDO) CREEL MODEL FG (RIGID YARN)

Fileta para alimentación de hilos en urdidores u otras máquinas, instalando un sistema giratorio en la reja porta conos, éste facilita la carga de bobinas desde el exterior. Especialmente diseñada para bobinas de gran peso. También podemos realizar la carga durante el proceso de urdido. Las rejas porta tensores son móviles para ajustar la distancia entre el tensor y la salida del hilo de la bobina, que puede ser interior o exterior.

It is a creel to feed yarn to warpers or to other types of machines. The cone-holders panels have a revolving system to facilitate the loading of the bobbins from the outside. This model is specially designed for big a heavy bobbins. The loading process can be done while the machine is running. The cone-holder panels can be moved in order to adjust the distance between the tensioner and the thread draw, and this can be inside or outside.



### DATOS TÉCNICOS A DEFINIR | TECHNICAL SPECIFICATIONS TO BE DEFINED

SALIDA HILO INTERIOR / EXTERIOR	TO INSIDE   TO OUTSIDE THREAD EXIT	
HILOS TOTALES	TOTAL THREADS	
PISOS ALTURA	FLOORS HIGH	
HILERA DE FONDO	ROWS DEEP	
ACARTAMIENTO VERTICAL	VERTICAL DISTANCE BET. BOBBINS	
ACARTAMIENTO HORIZONTAL	HORITZONTAL DISTANCE BET. BOBBINS	
TIPO DE TENSOR	THREAD GUIDE TYPE	
TIPO DE PORTACONOS	TENSIONER TYPE	
TIPO GUÍA-HILOS	BOBBIN-HOLDER TYPE	
TIPO DE DISPARO	STOP-MOTION TYPE	

## FILETA MODELO FC HILO RIGIDO) CREEL MODEL FC (RIGID YARN)

Fileta para alimentación de hilos en urdidores u otras máquinas, con sistema de carros intercambiables, con lo cual se puede realizar la carga fuera de la fileta. Las rejas porta tensores son móviles para ajustar la distancia entre el tensor y la salida del hilo en la bobina.

It is a creel to feed yarn to warpers or to other types of machines. It consists in a interchangeable trucks system, which allows an outside loading.

The cone-holder panels can be moved in order to adjust the distance between the tensioner and the thread draw, and this can be inside or outside.

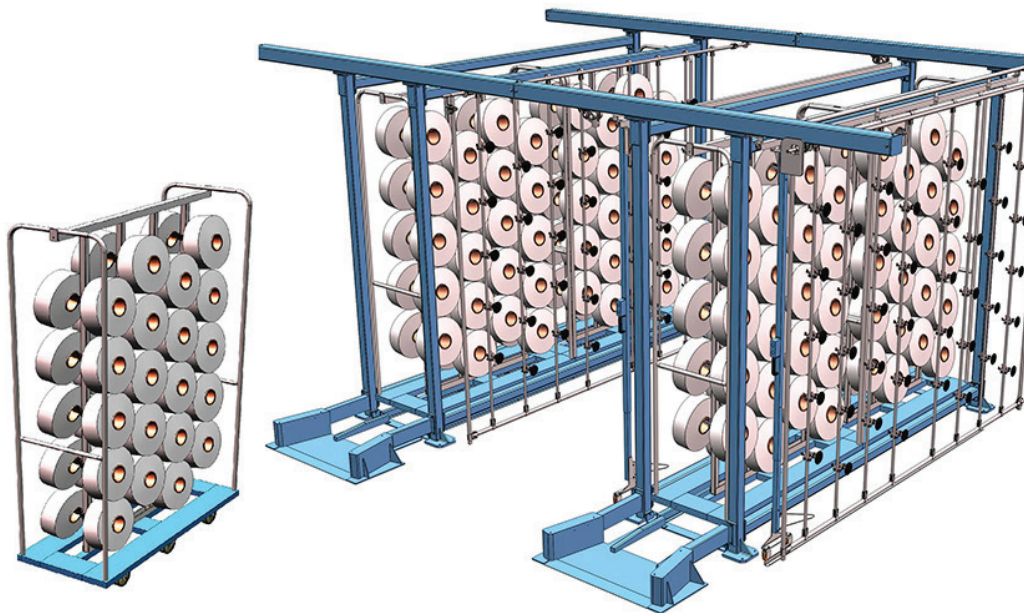

### DATOS TÉCNICOS A DEFINIR | TECHNICAL SPECIFICATIONS TO BE DEFINED

SALIDA HILO INTERIOR / EXTERIOR	TO INSIDE   TO OUTSIDE THREAD EXIT	
HILOS TOTALES	TOTAL THREADS	
PISOS ALTURA	FLOORS HIGH	
HILERA DE FONDO	ROWS DEEP	
ACARTAMIENTO VERTICAL	VERTICAL DISTANCE BET. BOBBINS	
ACARTAMIENTO HORIZONTAL	HORITZONTAL DISTANCE BET. BOBBINS	
TIPO DE TENSOR	THREAD GUIDE TYPE	
TIPO DE PORTACONOS	TENSIONER TYPE	
TIPO GUÍA-HILOS	BOBBIN-HOLDER TYPE	
TIPO DE DISPARO	STOP-MOTION TYPE	



## FILETA MODELO FPS (HILO RIGIDO) CREEL MODEL FPS (RIGID YARN)

Fileta para alimentación de hilos en urdidores u otras máquinas. La carga de bobinas se efectúa desde la parte trasera. La salida del hilo puede ser desde el interior o exterior.

It is a creel to feed warpers and other machines. . The loading process is made from the backside of the creel. The thread draw-off can be from inside or outside.

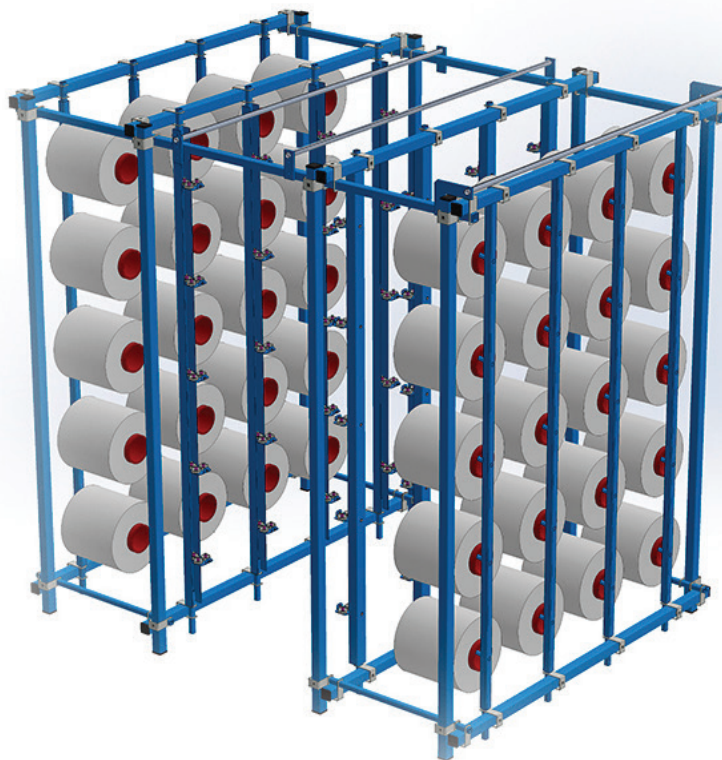

### DATOS TÉCNICOS A DEFINIR | TECHNICAL SPECIFICATIONS TO BE DEFINED

SALIDA HILO INTERIOR / EXTERIOR	TO INSIDE   TO OUTSIDE THREAD EXIT	
HILOS TOTALES	TOTAL THREADS	
PISOS ALTURA	FLOORS HIGH	
HILERA DE FONDO	ROWS DEEP	
ACARTAMIENTO VERTICAL	VERTICAL DISTANCE BET. BOBBINS	
ACARTAMIENTO HORIZONTAL	HORITZONTAL DISTANCE BET. BOBBINS	
TIPO DE TENSOR	THREAD GUIDE TYPE	
TIPO DE PORTACONOS	TENSIONER TYPE	
TIPO GUÍA-HILOS	BOBBIN-HOLDER TYPE	
TIPO DE DISPARO	STOP-MOTION TYPE	

**FILETA MODELO FAPY (HILO ELASTOMERO)  
CREEL MODEL FAPY (EASTOMERIC YARN)**

Fileta para urdir con alimentación positiva hilos elastómeros desnudos o recubiertos. El sistema de alimentación de rodillos es vertical. Dispone de porta conos de diam. 74 mm x 57 mm.

This is a positive feeding creel to warp elastomeric yarn, both raw and coated. It is provided of vertical feeding rollers system and cone-holders of diam. 74 x 57 mm.

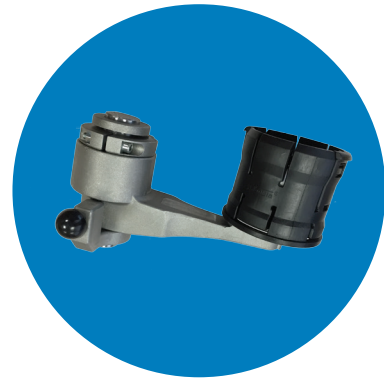

**DATOS TÉCNICOS A DEFINIR | TECHNICAL SPECIFICATIONS TO BE DEFINED**

SALIDA HILO INTERIOR / EXTERIOR	TO INSIDE   TO OUTSIDE THREAD EXIT	
HILOS TOTALES	TOTAL THREADS	
PISOS ALTURA	FLOORS HIGH	
HILERA DE FONDO	ROWS DEEP	
ACARTAMIENTO VERTICAL	VERTICAL DISTANCE BET. BOBBINS	
ACARTAMIENTO HORIZONTAL	HORITZONTAL DISTANCE BET. BOBBINS	
TIPO DE TENSOR	THREAD GUIDE TYPE	
TIPO DE PORTACONOS	TENSIONER TYPE	
TIPO GUÍA-HILOS	BOBBIN-HOLDER TYPE	
TIPO DE DISPARO	STOP-MOTION TYPE	

## FILETA MODELO FAP (HILO ELASTOMERO) CREEL MODEL FAP (EASTOMERIC YARN)

Fileta para urdir con alimentación positiva hilos elastómeros desnudos o recubiertos. El sistema de alimentación de rodillos es horizontal. Dispone de cerámica especial de reenvío en la salida del rodillo y porta conos de diam. 74 x 57 mm.

This is a positive feeding creel to warp elastomeric yarn, both raw and coated. It is provided of a special ceramic unit for forwarding, vertical feeding rollers system and cone-holders of diam. 74 x 57 mm.

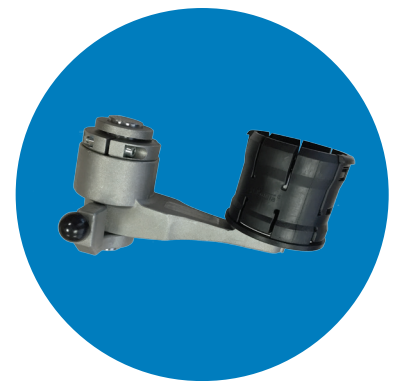

### DATOS TÉCNICOS A DEFINIR | TECHNICAL SPECIFICATIONS TO BE DEFINED

SALIDA HILO INTERIOR / EXTERIOR	TO INSIDE   TO OUTSIDE THREAD EXIT	
HILOS TOTALES	TOTAL THREADS	
PISOS ALTURA	FLOORS HIGH	
HILERA DE FONDO	ROWS DEEP	
ACARTAMIENTO VERTICAL	VERTICAL DISTANCE BET. BOBBINS	
ACARTAMIENTO HORIZONTAL	HORITZONTAL DISTANCE BET. BOBBINS	
TIPO DE TENSOR	THREAD GUIDE TYPE	
TIPO DE PORTACONOS	TENSIONER TYPE	
TIPO GUÍA-HILOS	BOBBIN-HOLDER TYPE	
TIPO DE DISPARO	STOP-MOTION TYPE	



## FILETA MODELO FAP (HILO ELASTOMERO) CREEL MODEL FAP (EASTOMERIC YARN)

Fileta para urdir con alimentación positiva hilos elastómeros desnudos o recubiertos. El sistema de alimentación de rodillos es horizontal. Dispone de cerámica especial de reenvío en la salida del rodillo y porta conos de diam. 74 mm x 230 mm o 48 x 230 mm.

This is a positive feeding creel to warp elastomeric yarn, both raw and coated. It is provided of a special ceramic unit for forwarding, vertical feeding rollers system and cone-holders of diam. 74 x 230 mm or diam. 48 x 230 mm.



### DATOS TÉCNICOS A DEFINIR | TECHNICAL SPECIFICATIONS TO BE DEFINED

SALIDA HILO INTERIOR / EXTERIOR	TO INSIDE   TO OUTSIDE THREAD EXIT	
HILOS TOTALES	TOTAL THREADS	
PISOS ALTURA	FLOORS HIGH	
HILERA DE FONDO	ROWS DEEP	
ACARTAMIENTO VERTICAL	VERTICAL DISTANCE BET. BOBBINS	
ACARTAMIENTO HORIZONTAL	HORITZONTAL DISTANCE BET. BOBBINS	
TIPO DE TENSOR	THREAD GUIDE TYPE	
TIPO DE PORTACONOS	TENSIONER TYPE	
TIPO GUÍA-HILOS	BOBBIN-HOLDER TYPE	
TIPO DE DISPARO	STOP-MOTION TYPE	

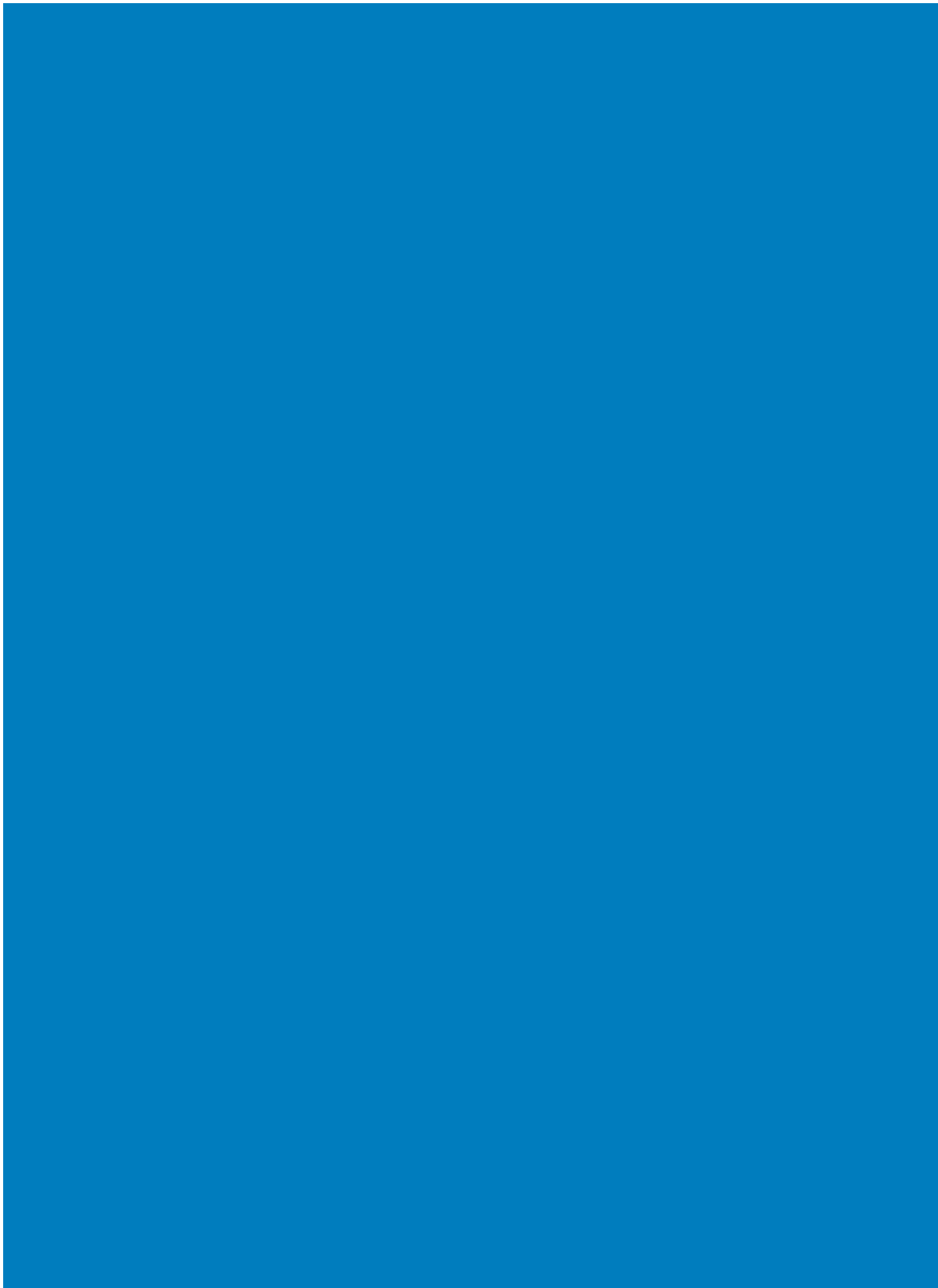

**TENSORES TENSIONERS  
PORTACONOS CONE-HOLDERS  
GUIA-HILOS THREADS GUIDE  
VARIOS VARIOUS**

## TENSORES TENSIONERS

### THS-1



Tensor hidráulico desde 20 hasta 170 dtex  
Hydraulic tensioner from 20 to 170 dtex

### THS-2

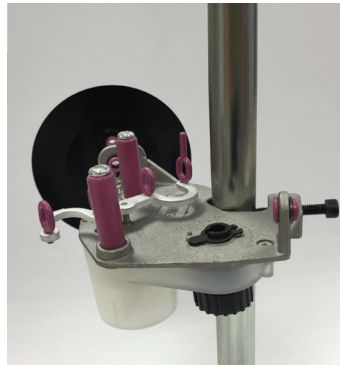

Tensor hidráulico desde 40 hasta 400 dtex  
Hydraulic tensioner from 40 to 400 dtex

### THP/A

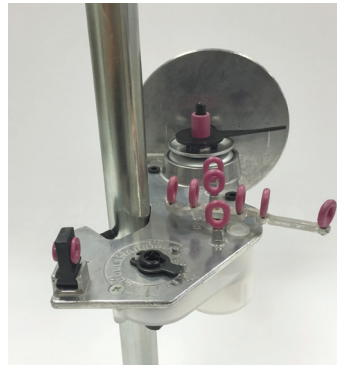

Tensor hidráulico desde 20 hasta 170 dtex  
Hydraulic tensioner from 20 to 170 dtex

### TPS



Tensor 3 pivotes desde 0 hasta 1000 dtex  
Tensioner with 3 pins from 0 to 1000 dtex

### TV3

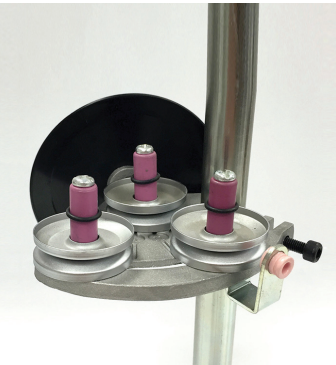

Tensor 3 pivotes desde 0 hasta 3000 dtex  
Tensioner with 0 pins from 0 to 3000 dtex

### THP/S

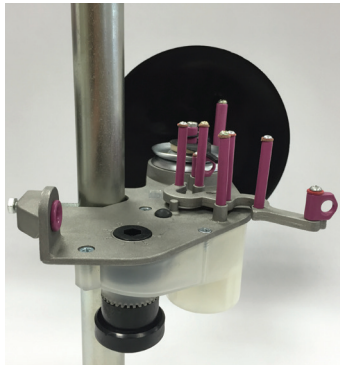

Tensor hidráulico desde 80 hasta 3000 dtex  
Hydraulic tensioner from 80 to 3000 dtex

### TB



Tensor basculante desde 0 hasta 3000 dtex  
Swiveling tensioner from 0 to 3000 dtex

### TA

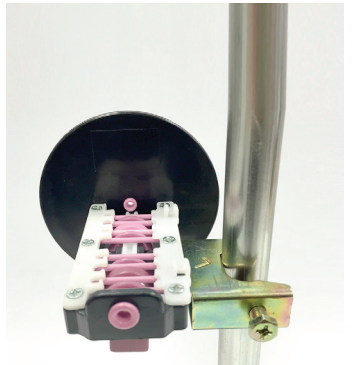

Tensor anillos desde 20 hasta 500 dtex  
Ring tensioner from 20 to 500 dtex

### TDP

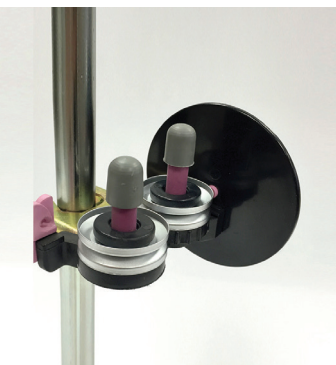

Tensor 2 pivotes desde 30 hasta 400 dtex  
Tensioner with 2 pins from 30 to 400 dtex

### TRP



Tensor de rodillos de plato redondo desde 20 hasta 300 dtex  
Round plated roller tensioner from 20 to 300 dtex

### TRC



Tensor de rodillos de plato rectangular desde 20 hasta 300 dtex  
Rectangular plated roller tensioner from 20 to 300 dtex

### TM



Tensor de muelle regulable desde 20 hasta 300 dtex  
Tensioner with adjustable spring from 20 to 300 dtex

**PBC**



**PGR RESERVA RESERVE PEM**



**PMS**



**PMD**



**PMR**



**PGD**



**PLY DIAM. 74/230**



**PLY DIAM. 48 /230**



**PLY DIAM. 74 / 230**



**PLY DIAM. 74 / 57**





## GUIA-HILOS THREADS GUIDE

### GR

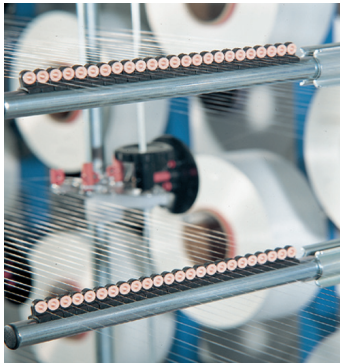

Guía hilos GR, sobre tubo de diam. 20 mm. y ojales diam. 3-4-6 mm.  
Thread guide on a diam. 20 mm tube, with diam. 3-4-6 mm eyelettes.

### GRD

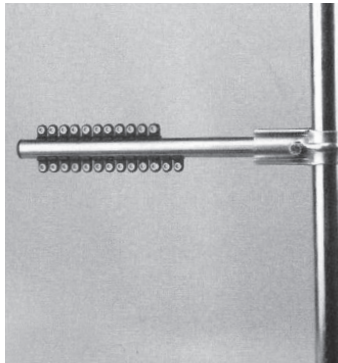

Guía hilos GRD sobre tubo diam. 20 mm y ojales diam. 3-4-6 mm en 2 pisos.  
Threads guide on a diam. 20 mm tube, with diam. 3-4-6 mm eyelettes.

### GF

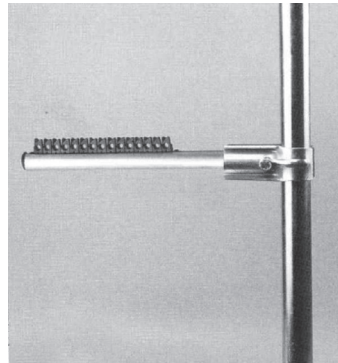

Guía hilos sobre tubo diam. 20 mm y cerâmicas de enhebrado rápido.  
Threads guide on a diam 20 mm tube with easy-threading ceramics.

### CGE



Guía hilos elastómero CGE.  
Threads guide for elastomeric yarn CGE.

### CGE



Guía hilos elastómero CGE.  
Threads guide for elastomeric yarn CGE.

### GRE

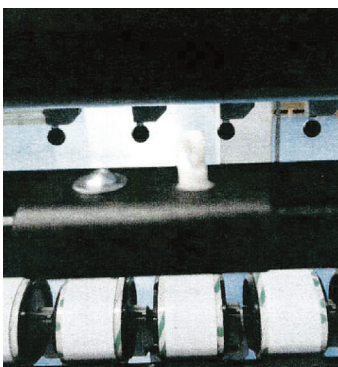

Guía hilos elastómero GRE.  
Threads guide for elastomeric yarn GRE.

### GRE

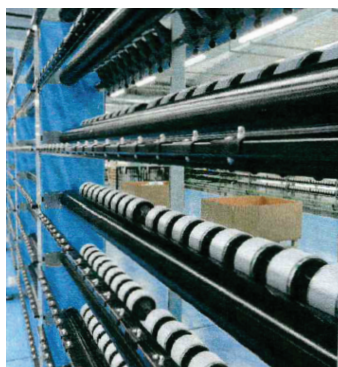

Guía hilos elastómero GRE.  
Threads guide for elastomeric yarn GRE.



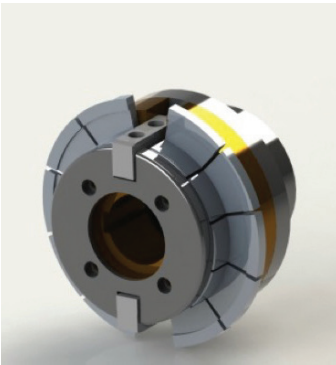

Entrenadores 6" y 4,5".  
Beam chucks 6" and 4,5".

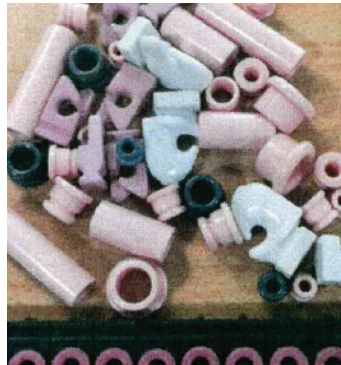

Cerámicas varias.  
Set of textile ceramics.



Laser stop para elastómero.  
Laser stop for elastomeric yarn.

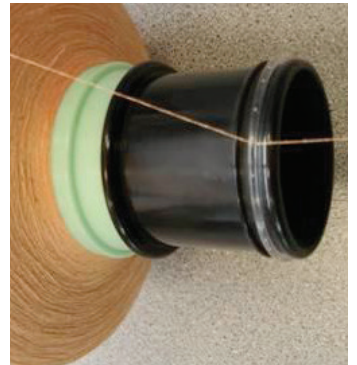

Unwinding caps (varios).  
TU unwinding caps (various).



Disparos DEF.  
Stop motion DEF.



Disparos DEF.  
Stop motion DEF.

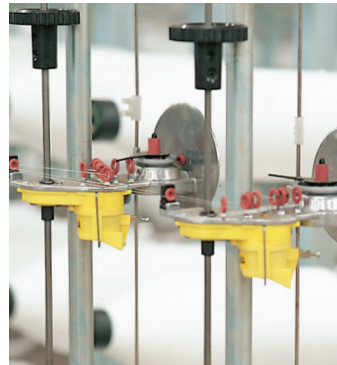

Disparo TDH.  
Stop motion TDH.

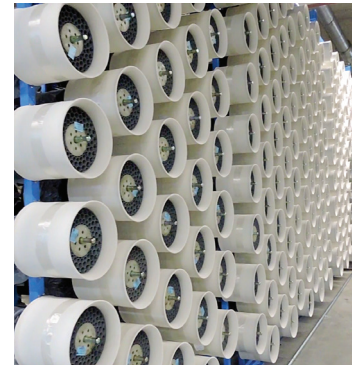

Tubo antibalón monofilamento TAM.  
Anti-balloon tube for monofilament TAM.



Plomos urdidor (1").  
Comb leads for Warper (1").

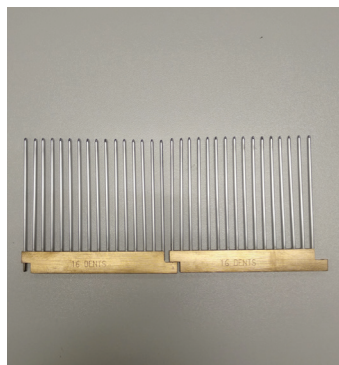

Peines urdidor (100 ml).  
Warper combs (100 ml).



Eliminadores de electricidad estática.  
Static electricity eliminator.

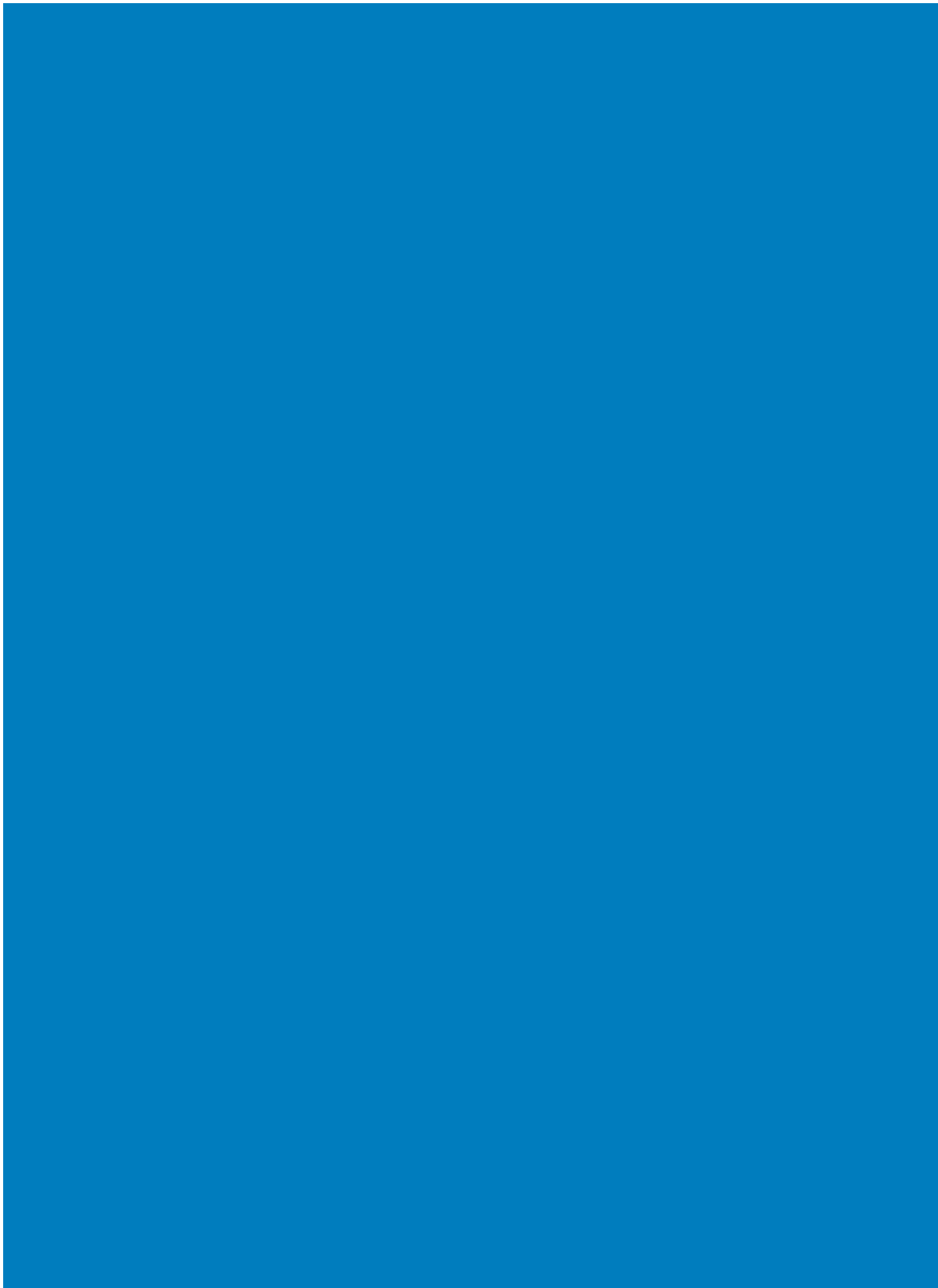

**PLEGADORES BEAMS**  
**PALETAS RACKS**

## PLEGADORES BEAMS

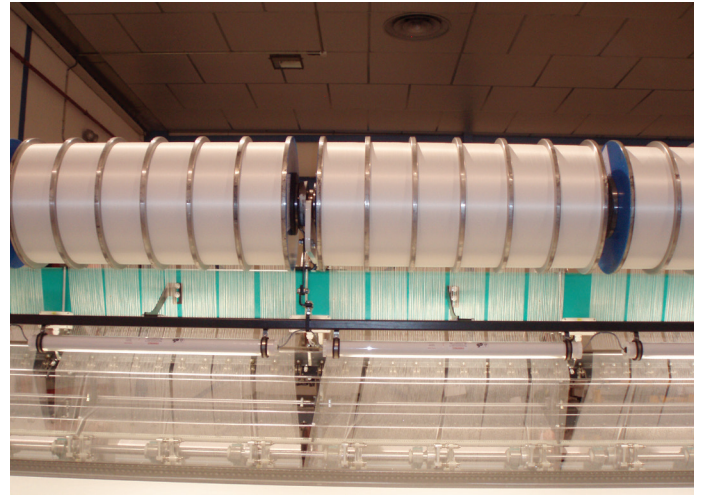
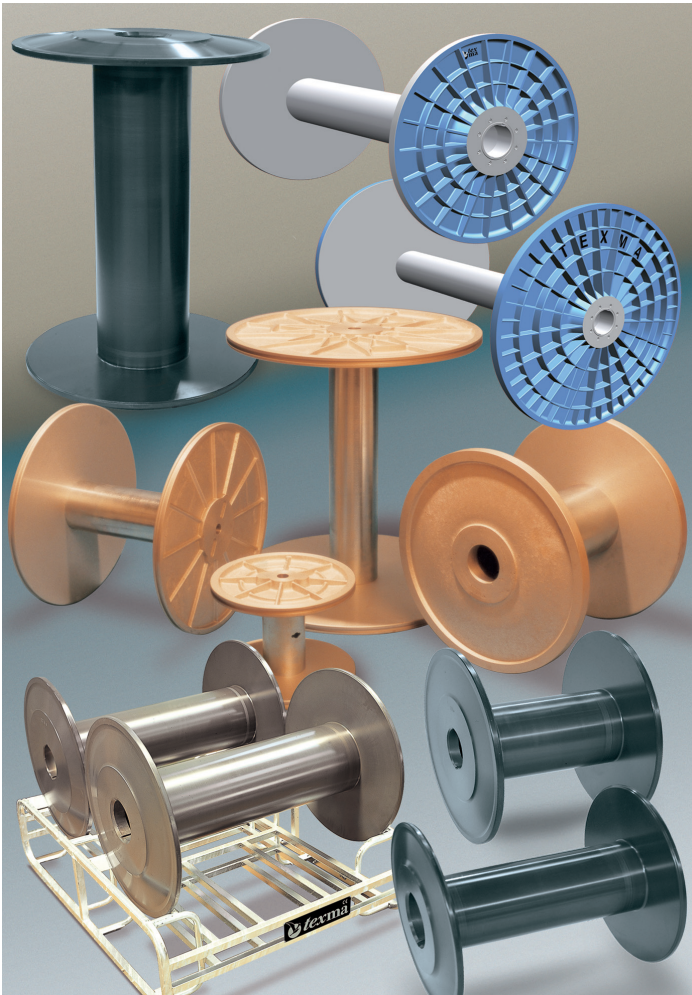

Plegadores para el sector de la cintería:  
Desde diámetro 200 mm. hasta 1000 mm. y anchos a definir.

Beams for narrow fabrics:  
From diam. 200 mm to 1.000 m. Width can be decided.

### PLEGADORES PARA EL SECTOR DEL PUNTO BEAMS FOR WARP KNITTING SECTOR

21" x 21"	30" x 42"
21" x 42"	30" x 50"
21" x 50"	30 x 65"
21" x 65"	40 x 21"
30" x 21"	40" x 30"
30" x 30"	40" x 42"

### SECCIONALES SECTIONAL BEAMS

21" x 21" (3 secciones   3 sections)
21" x 42" (6 secciones   6 sections)





Para el sector de tisaje , diámetros y largos a definir.

For weaving sector, diameter and length can be decided.

**PALETAS PARA EL SECTOR DE GÉNERO DE PUNTO | RACKS FOR WARP KNITTING BEAMS**

4 plegadores (beams) de 21" x 21"	4 plegadores (beams) de 30" x 30"	2 plegadores (beams) de 40" x 21"
2 plegadores (beams) de 21" x 42"	2 plegadores (beams) de 30" x 42"	2 plegadores (beams) de 40" x 30"
2 plegadores (beams) de 21" x 50"	2 plegadores (beams) de 30" x 42" o 4 Plegadores de 30" x 21"	1 plegador (beam) de 40" x 42"
2 plegadores (beams) de 21" x 65"	2 plegadores (beams) de 30" x 50"	
4 plegadores (beams) de 21" x 65"	2 plegadores (beams) de 30" x 65"	
4 plegadores (beams) de 30" x 21"	2 plegadores (beams) de 40" x 21"	







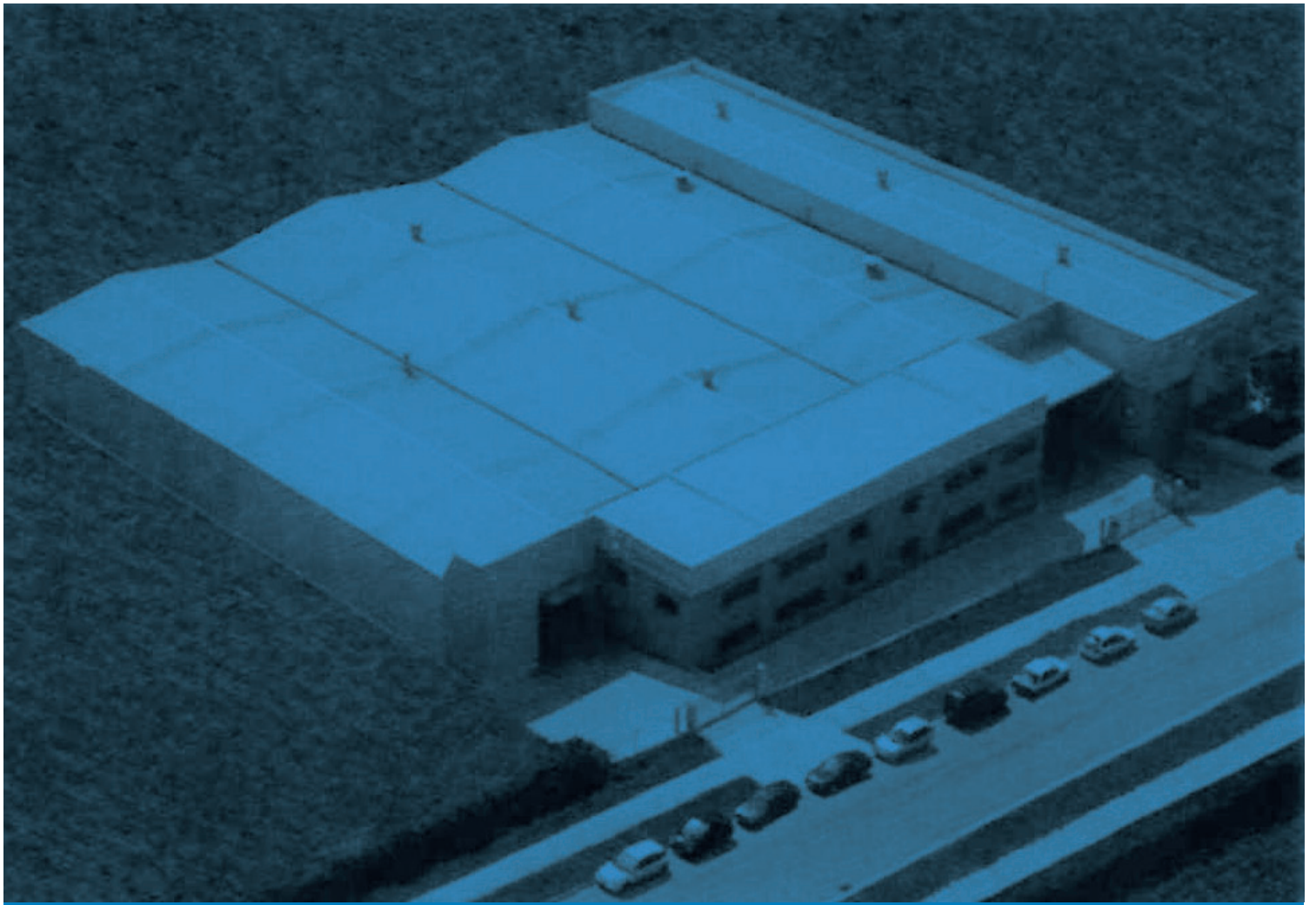

**EL SERVICIO EXCELENTE ES NUESTRA PRIORIDAD**  
**EXCELLENT SERVICE IS OUR PRIORITY**

**Texma**<sup>®</sup>-AMC  
MACHINERY, S.L.

C/Ramon Farguell, N6 ( P.I. Bufalvent )  
P.O.Box.:250  
08243 Manresa (Barcelona) | SPAIN

Tel: +34 938 739 898  
Fax: +34 938 737 667  
E-mail: [texma@texma.com](mailto:texma@texma.com)

[www.texma.com](http://www.texma.com)